



ABS KIT fitting instructions
Audi RS 3 LMS MY2021

ABS M5 Hydraulic connection

Complete kit

Content:

- 1 x ABS set (Unit, Accelerometer, Sensors)
- 1 x Loom ABS
- 1 x Power box

- 1 x Set of brake line
- 1 x Set of fitting and adaptors

5FR614111
5FR971279
5FR907079

no ref.
no ref.

Brake line (not available on the catalogue)

- 1 x PIPE FRONT M.CYLINDER TO ABS **MC1**
- 1 x PIPE PROP VALVE TO ABS UNIT **MC2**
- 2 x PIPE ABS **FL/FR** TO FRONTDISTRIBUTOR
- 1 x PIPE ABS **RL** TO REAR DISTRIBUTOR
- 1 x PIPE ABS **RR** TO REAR DISTRIBUTOR

5FR614723
5FR614724
5FR614725
5FR614727
5FR614728

Fitting set (not available on the catalogue)

- 2 x RACORD 03D/M10X1/03D
- 2 x RACORD 12X1 - 03D
- 4 x BULKHEAD ADAPTER
- 2 x T BRAKE BRACKET
- 2x T BRAKE BRACKET
- 2 x DISTRIBUTOR
- 8 x CLAMP DOBLE 2xØ7,5

VN0005102900
V2MT31161
_6KL611315
5F6611320
5F6611321
VN0005110400
_8A0201687

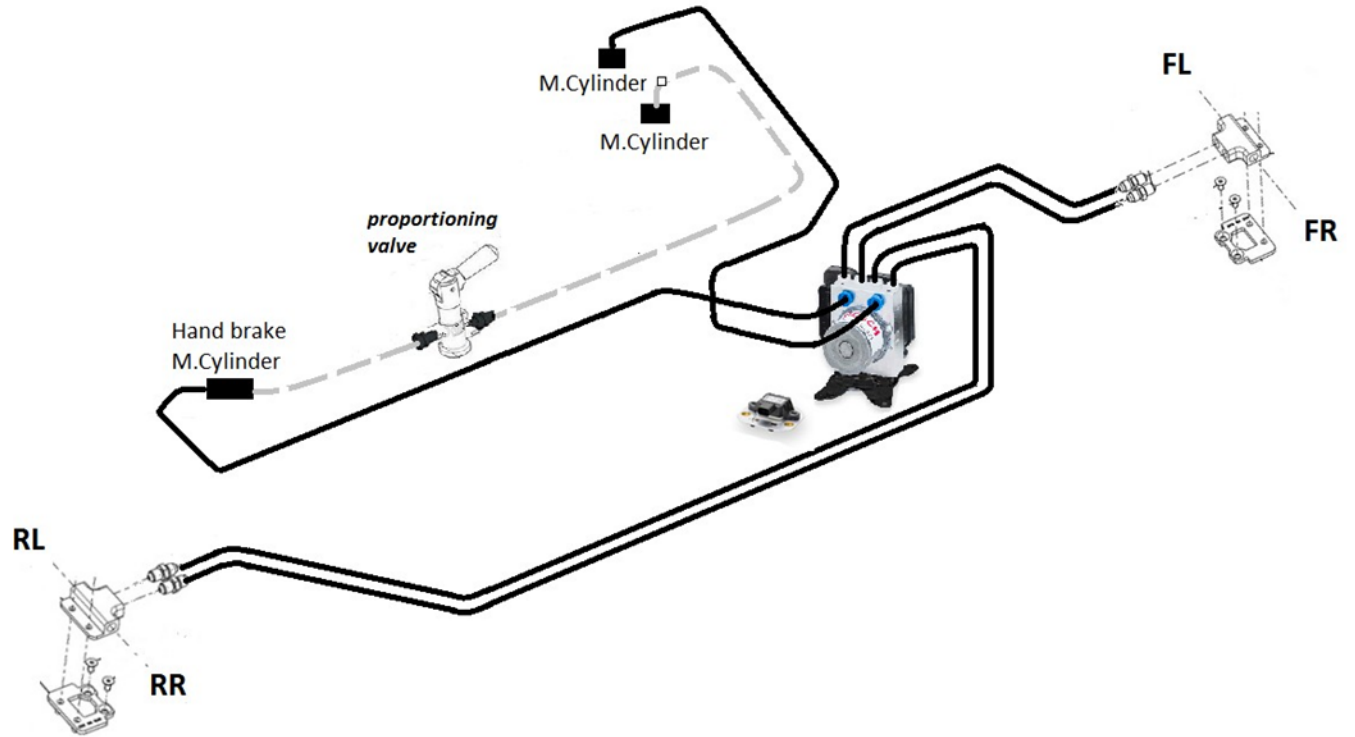

- 2 X ALLEN M6X20 ZN.10.9 ISO7380
- 4 X ALLEN M5X16 ZN.8.8 DIN912
- 4 X ALLEN M5X12 ZN.10.9 DIN7991
- 1 X WASHER.Ø10XØ20X2 ZN. DIN125
- 2 X WASHER.Ø10XØ16X2 CU. DIN7603
- 2 X WASHER.Ø6XØ12X1.6 ZN. DIN12
- 4 X NUT AVIACION 6C M6 CADMIO
- 4 X SILENTBLOCK CIL. M6X20X15

VN000191551
VN0001148816
VN0001816318
VN0002001010
VN0002341500
VN0002000710
VN0003220400
VN0008086500

ABS M5 Hydraulic connection

- 1 MC2: Brake master cylinder rear
- 2 RR: Brake cylinder rear right
- 3 RL: Brake cylinder rear left
- 4 FR: Brake cylinder front right
- 5 FL: Brake cylinder front left
- 6 MC1: Brake master cylinder front

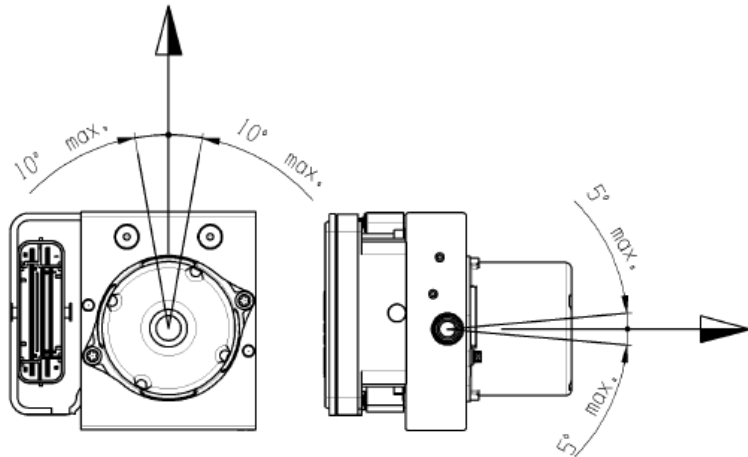

*mount the ABS unit in the position indicated by the brand. (Over central tunnel, in front)

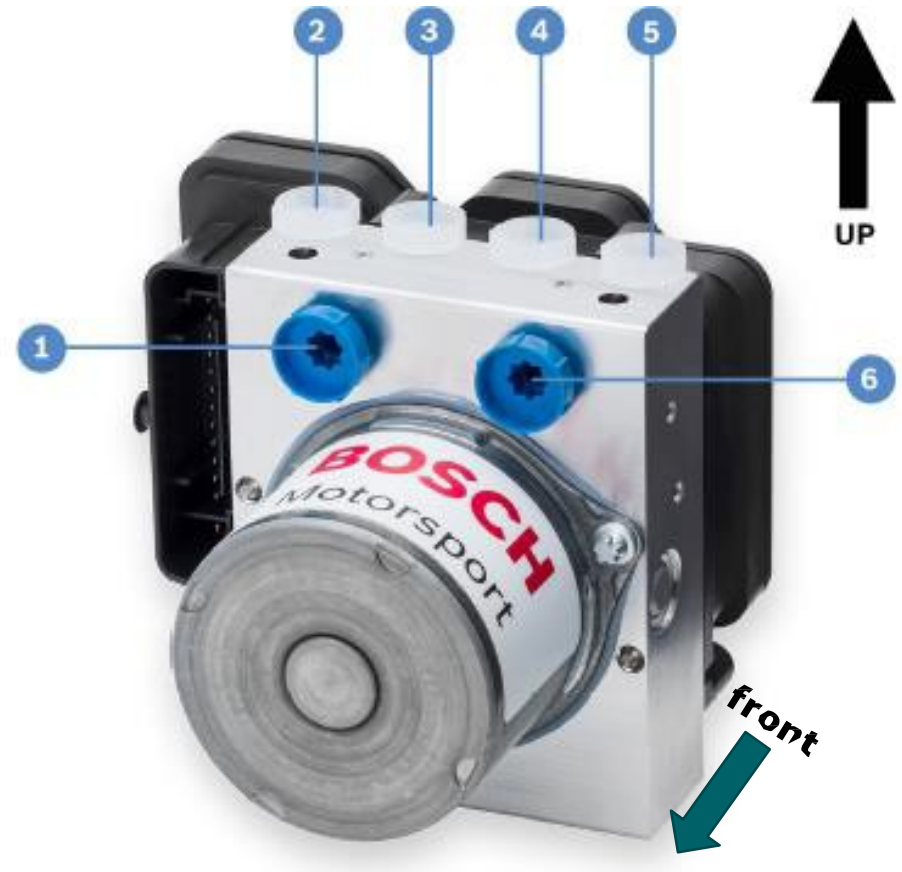
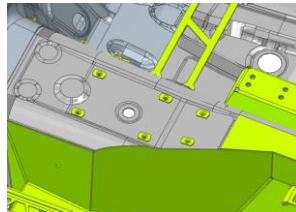

ABS Bosch

Inlet ports thread M12x1 (2x)

Outlet ports thread M10x1 (4x)

Units in location



View of the ABS unit and accelerometer in location

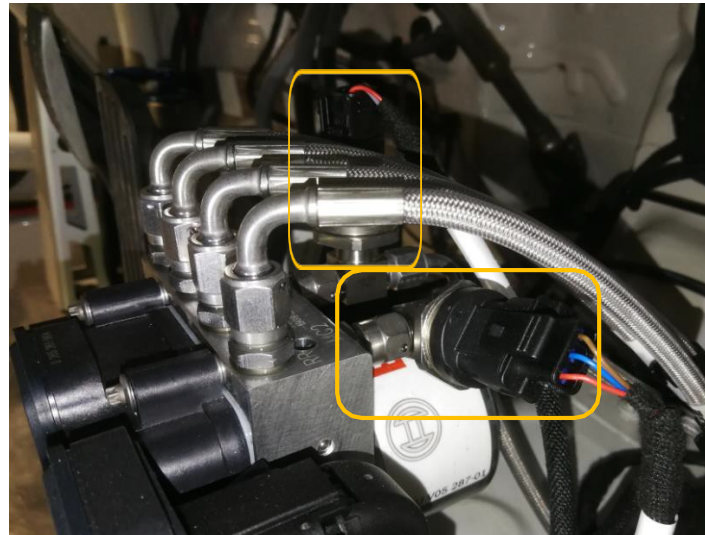

View of the Inlet Pressure brake sensors in location
Install the pressure sensors over the T adaptor to the MC1 / MC2 ports

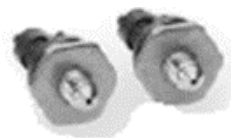

View of the PWB (power box unit) in location
Install the PWB using hook and loop tape (3M)



Loom connection

1. Speeds
2. CAN ABS
3. PWB
4. PWB
5. P_brake
6. P_brake
7. YAW & accelerometer
8. Power supply
9. GND

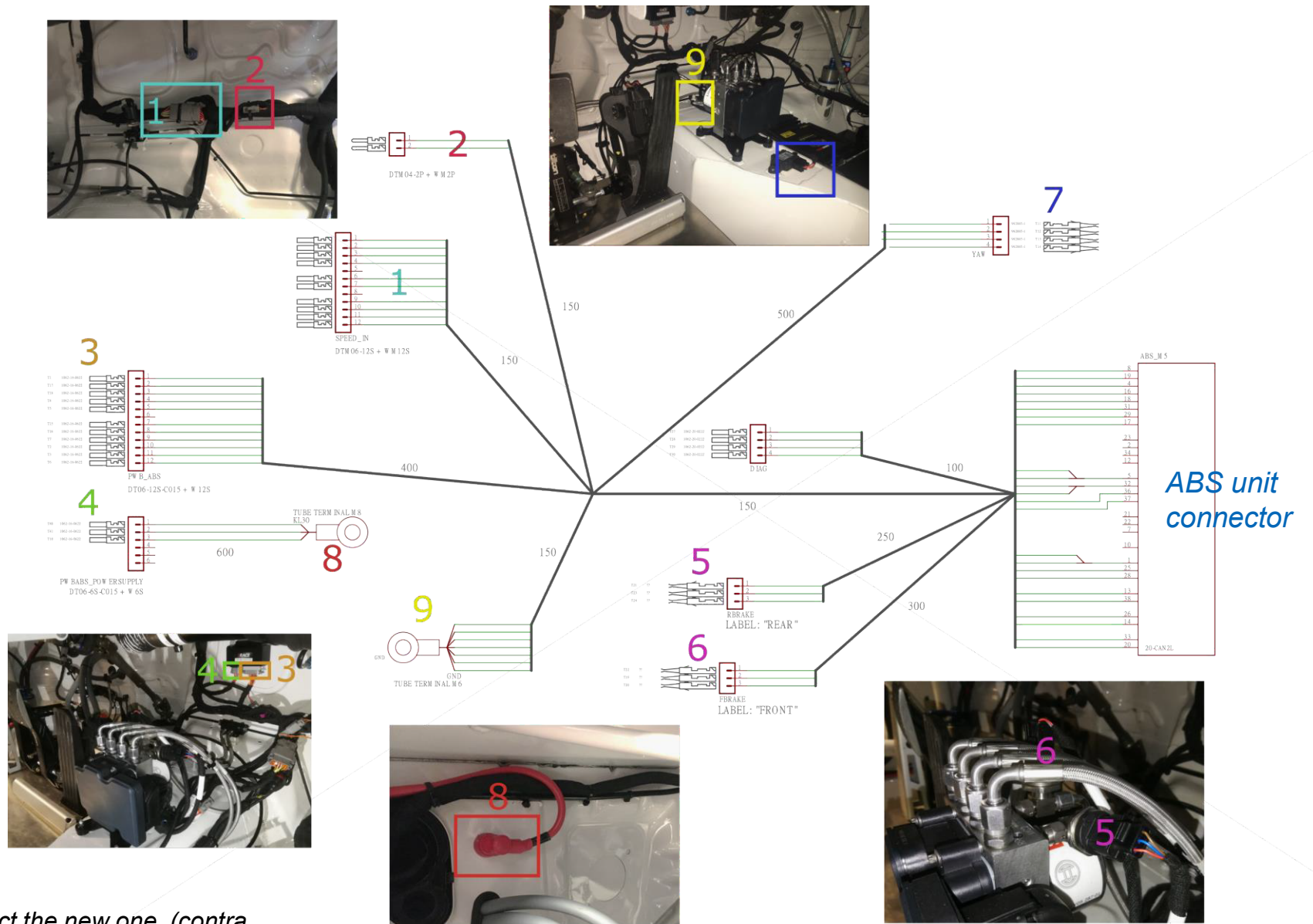

1. Speeds: Open the connector and connect the new one. (contra connector will remain open, protect and fix it)

Electronic installation & usage

The system is electronically plug and play*.

When the car detects the ABS unit the display screen and steering wheel function become active.

Short Push to de the ABS button in the steering wheel to activate / deactivate the system. To change between the 11 maps available (12=OFF), click up/down (left ones) & ABS button simultaneously.

(Same procedure used to change the PIT Limiter or FCY speeds)

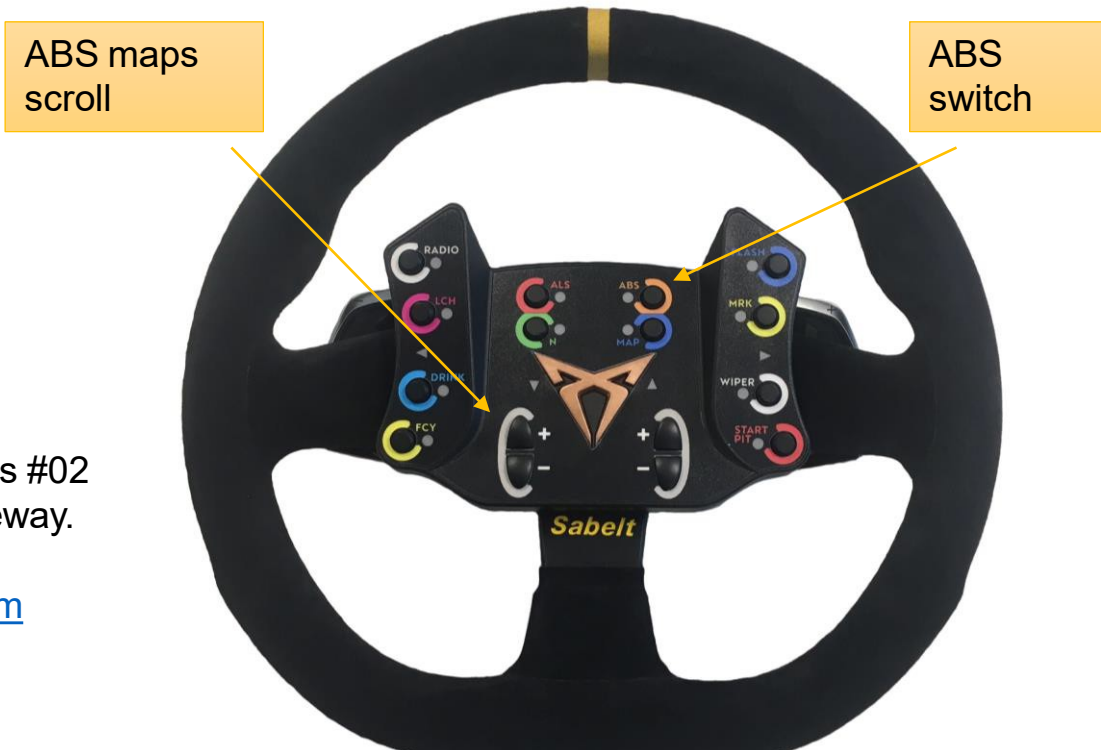

*Cupra Leon Competition chassis #02 to #020 needs to update the gateway.

To do it, contact:

technical@cupraofficial.com